



PROJECT DESCRIPTION:  
**FLARED POT**  
 NO17 17 1/2" dia x 7 1/2" tall

DRAWN BY:  
 V. TOSHANOVA

APPROVED BY:

SCALE:

DATE:

DWG NO:

REV DATE:

12665 116 Ave Surrey, BC V3V 3S6 Ph. 604-580-4108 toll free 800-671-8882 FAX. 604-580-411 info@sandersonconcrete.com

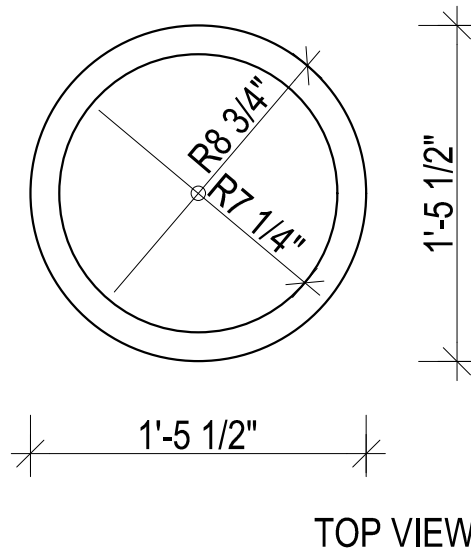
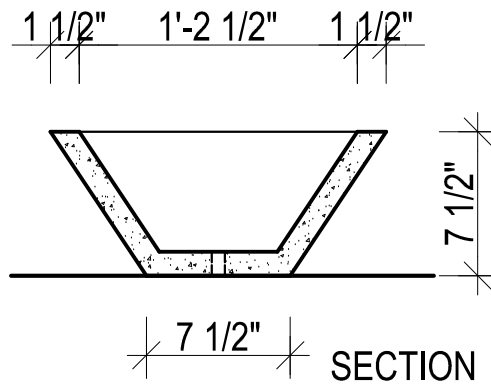

FLARED POT NO17	Diameter x Height	weight
	17 1/2" X 7 1/2"	42 lbs