



PROJECT DESCRIPTION:

MEDIUM BOWL PLANTER
LA3 29" dia x 14" tall

DRAWN BY:

V. TOSHANOVA

APPROVED BY:

SCALE:

DATE:

DWG NO:

REV DATE:

12665 116 Ave Surrey, BC V3V 3S6 Ph. 604-580-4108 toll free 800-671-8882 FAX. 604-580-411 info@sandersonconcrete.com

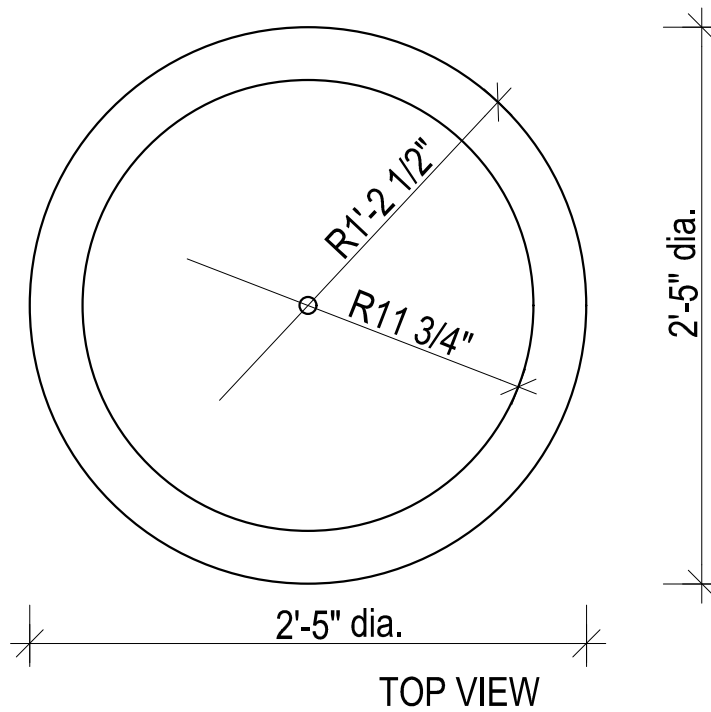
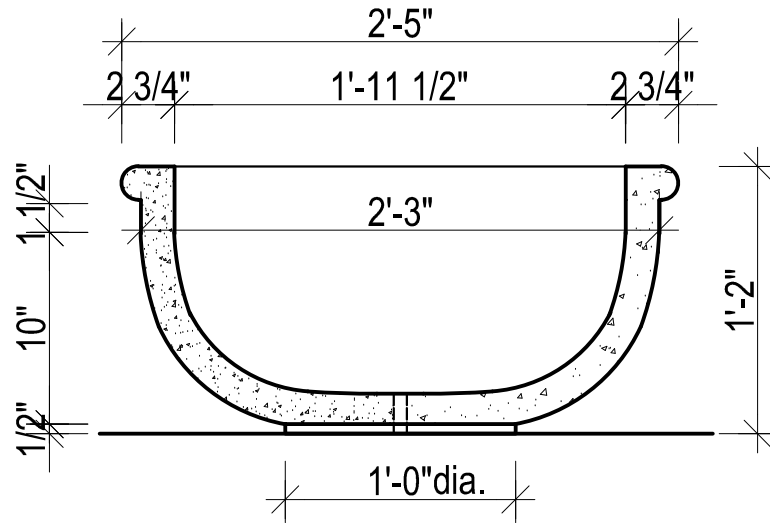

MEDIUM BOWL PLANTER	Diameter x Height	weight
LA3	29" X 14"	200 lbs